



PE1000 Power Engine System Manual



Optical Engines Inc.
2829 W. Colorado Ave
Colorado Springs, CO 80904 USA
(719) 203-5650



Contents

Contents	1
1.0 System Overview	3
1.1 Introduction	3
1.2 Support	4
1.3 Explanations & Symbol Identification	5
1.4 Safety Symbols	7
1.5 Warning Labels	10
2.0 Safety Considerations	11
2.1 Laser Safety	11
2.2 Requirements of the Manufacturer	11
2.3 Requirements of the Integrator	12
2.4 Requirements of the Operator	12
2.5 Residual Risks	13
2.6 Risks from Incorrect Installation	15
2.7 Hazards Due to Laser System Malfunction	15
2.8 General Safety Considerations	15
3.0 System Setup Guide	16
3.1 System Overview - Identification of Parts	16
3.2 Mechanical Features	17
3.3 System Setup	18



4.0 System Operation	20
4.1 Control Interface - Software	20
4.1.1 Installation	20
4.1.2 Software Diagram	21
4.1.3 Software Operation	22
4.1.3.1 Connecting	22
4.1.3.2 Main GUI	23
4.1.3.3 Manage Laser Uptime	27
4.1.3.4 Update Firmware/Configuration	28
4.1.4 Ethernet Connectivity	29
4.1.5 Software Errors	29
4.2 Control Interface - Analog Access (DB25)	34
4.3 Control Interface - Serial Communication (RS-232)	39
4.4 Water Cooling	39
4.5 Fiber Care	40
Appendix A - Command Index	41
A.1 - RS-232 Commands	41
A.2 Binary Commands	67
GetGlobalStateBinary (ID 131)	69
GetGlobalStateBinary (ID 132)	70
GetSensorStateBinary (ID 133)	71
GetStageStateBinary (ID 135)	72
Appendix B - Error Codes	73



1.0 System Overview

1.1 Introduction

This manual is intended to aid the operator of the laser system in understanding how to prepare, install, operate, and troubleshoot the laser system. The contents of this manual will assist in operating the device safely and properly. Following this manual will minimize risks, reduce repair costs, and increase reliability of both the electronics and the integrated laser.

The manual must be kept with the laser system, and available at all times. The manual must be read and applied by anyone who uses the laser system. Specific topics covered include:

- Setting up the working environment (laser safety, security policies)
- Operation, setup, and troubleshooting during use
- Assembly, installation, and system integration
- System maintenance, inspection, and transportation
- Guidelines to maximize system uptime

This manual provides guidelines for safe and reliable laser operation. In addition to following the instructions within this document, the user should adhere to all mandatory safety regulations, professional technical rules for laser safety, and any other professional guidelines for safe laser operation.



1.2 Support

Optical Engines, Inc.

E-mail: sales@opticalenginesinc.com

Tel: +1-719-203-5650

1.3 Explanations & Symbol Identification

This section provides definitions to the terms used the manual, along with symbols and their meaning. This guide is provided to lessen the chance of misunderstanding for which the manufacturer cannot be held responsible. It is extremely important that anyone operating the laser system fully understands the manual in order to safely operate the laser.

Manufacturer: The manufacturer is the legal entity specified on the nameplate of the equipment delivered to the customer.

Buyer: The buyer is the person or company who can testify to the lawful acquisition of the laser system. The buyer is not the user or operator of the system.

Operator: An operator is any person employed and authorized by the **Buyer** to operate and maintain the laser system. The system should not be used by anyone other than trained and authorized operators.

Subject Specialist: A subject specialist is characterized by his or her expertise relating to the hazards and risks of laser system operation. This person also has knowledge on how to avoid liability resulting from damage to persons or property.

Unfinished Machine: An unfinished machine is a unit purchasable from a dealer or manufacturer that is not suitable for direct use. The machine has mechanical and/or safety deficiencies which prevent safe and proper operation. When purchasing an unfinished machine, the **Buyer** is responsible for ensuring that the completed system is checked along with provisioning for the safe operation of the final product.

Finished Machine: A finished machine is a unit purchasable from a dealer or manufacturer which is complete and suitable for direct use. This claim is ensured by the manufacturer, and demonstrated via clear CE marking on the unit. This labeling certifies the manufacturer's claim that the product meets all applicable safety standards for proper operation.

Inspection: An inspection is the assessment of the current state of the machine. This action can only be performed by qualified personnel.

Maintenance: Maintenance refers to the performance of activities that have an effect on the state of the machine. All maintenance activities should be performed by the manufacturer, and the manufacturer cannot be held liable for damage to persons or property resulting from improper system maintenance by parties other than the manufacturer.







Repair: Repair work is any activity which restores the system to a safe, operable state. These activities may only be conducted by a trained person. The manufacturer cannot be held responsible for damage to persons or property resulting from repair work performed by entities other than the manufacturer.



Warranty: The warranty is the legal basis for the action taken between the Buyer and the Manufacturer in the case of a faulty system. While under warranty, the Manufacturer will provide additional services and perform necessary repair work to restore the system to a functional state within the terms of the warranty.

1.4 Safety Symbols











The following chart details the symbols used in this manual to indicate hazards based on DIN EN 61 310-1 along with other safety considerations.

Symbol	Explanation
	This symbol indicates an imminent danger to the lives and health of persons. Failure to follow this information can have serious health effects result in life-threatening injuries or death.
	This symbol indicates an imminent danger of electrical energy. Failure to follow the guidelines here can result in life-threatening injuries or death.
	This symbol is used to designate tips and other useful information. This symbol indicates a potentially hazardous situation for the operator. Disregarding these instructions can have serious adverse health effects, leading to life-threatening injuries or death.
	This symbol designates application tips and other useful information.

IMPORTANT: To ensure the safe use of this product, safety information is included within this section and throughout the manual at appropriate points to highlight key safety considerations. This safety information is in addition to any safety information relating to the laser beam and is highlighted with the IEC warning triangle.

Symbol	Explanation
	WARNING refers to a potential personal hazard. It requires a procedure which, if not correctly followed, may result in serious bodily harm or death to the operator and others. Do not proceed past the WARNING sign until you completely understand and meet the required conditions.
	CAUTION refers to a potential product hazard. It requires a procedure which, if not correctly followed, may result in damage to or destruction of the product or components. Do not proceed beyond the caution sign until you completely understand and meet the required conditions.
	IEC WARNING TRIANGLE refers to safety information related specifically to the laser output of this device.

The laser radiation figures below indicate various hazards of laser light. Ensure that any operator of the system is fully aware of the following figures and their meanings.

Symbol	Explanation
	Danger of coherent electromagnetic radiation
	Warning sign for Class IV laser beams
	Rated power and wavelength of the laser radiation
	Danger of personal injury due to dropping equipment
	Danger due to fire
	Danger due to explosion
	Danger due to toxic substances
	Risk of electrostatic discharge
	Danger from hot surfaces
	Wear safety shoes
	Wear laser safety glasses

The following list of applicable laser safety standards makes no claim for completeness or accuracy. The end user is responsible for knowledge of the standards applicable to the operation and management of a Class IV laser device. For special applications, additional standards may be required.

Standard	Details
DIN EN 60825-1	Laser safety, classification of laser systems, requirements and user policy
DIN EN 60825-4	Laser safety, laser guards, and safety measures
DIN EN 207	Personal safety protection - laser safety
DIN EN 208	Personal eye protection - laser adjustable glasses
21CFR1040.10	Performance standards for light emitting laser products
2006/42/EG	Machinery directive
2006/95/EG	Low voltage directives
2004/108/EG	Electromagnetic compatibility requirements
GPSG	Equipment and product safety act
1999/44/EG	Customer sales and warranty
BGV B2 UVV	Laser radiation
BGV A8	Safety and health signs at work
BGV A1	Principles of prevention
PSA - BV	Regulations on personal protective equipment users

1.5 Warning Labels

The laser system is equipped with several warning labels, describing the laser radiation exposure during normal operation and during servicing. The locations of these warning labels is shown below:

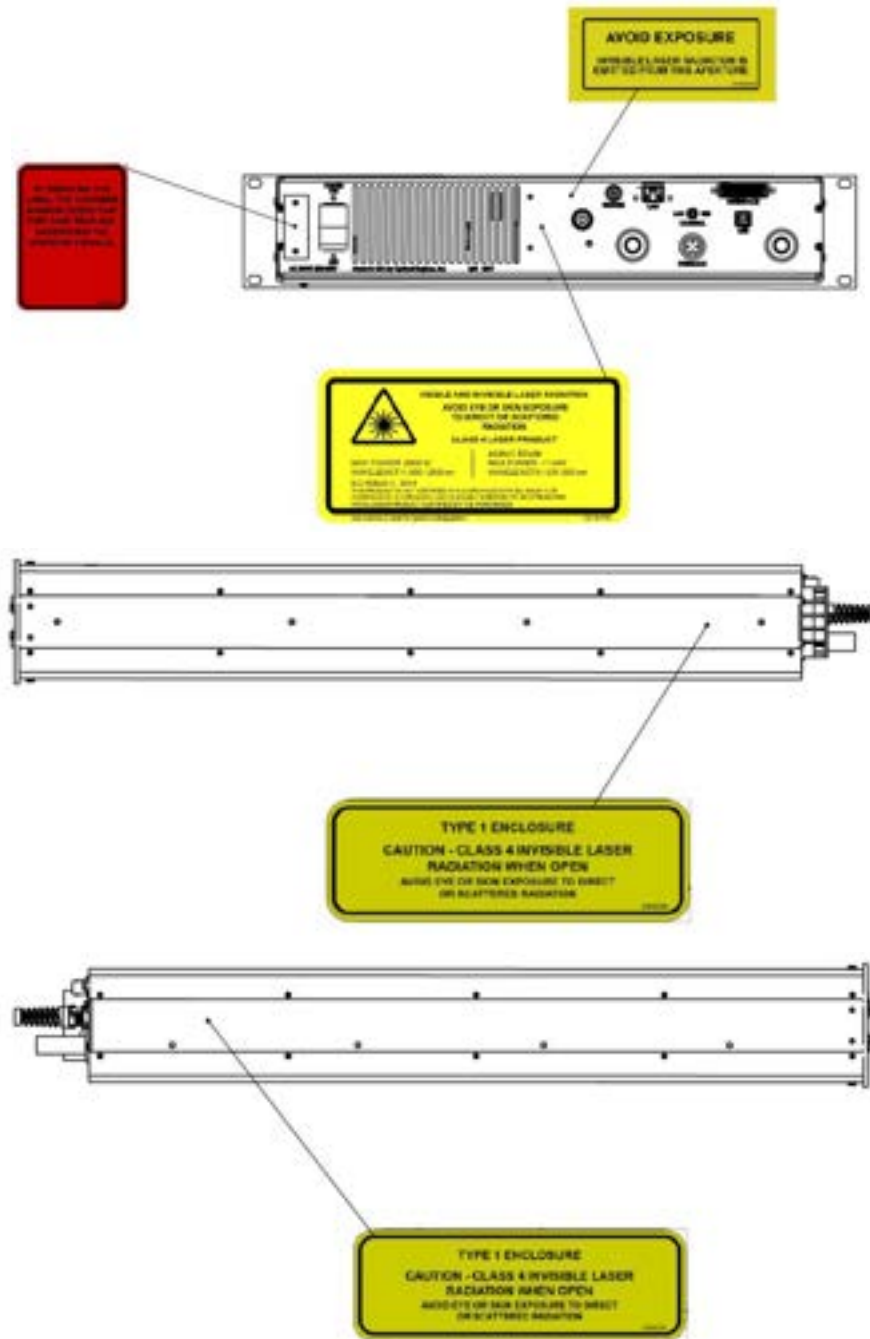

2.0 Safety Considerations

This laser system is manufactured and developed based on the latest findings in laser diode development, production, reliability, and safety guidelines. Nevertheless, improper system use can lead to extreme danger to persons or property.



The Equipment and Product Safety Act requires manufacturers to have operators and users observe generally accepted laser guidelines and standards, as well as the Occupational Safety and Accident Prevention regulations.

2.1 Laser Safety

Directive EN 60825-1 places tight specifications on the manufacturer and operator of a Class IV laser facility. Since the laser system is an unfinished machine, the requirements listed below are not currently met by the delivered device, and must be adhered to by the finalized device.



The laser system should not be put into service until all requirements of directive EN 60825-1 have been met.

2.2 Requirements of the Manufacturer

The manufacturer of the finished machine is required to ensure that adequate signage is present. The signage must:

- Be marked with required labels
- Make use of a warning light or sign installed on the device which warns nearby people of the current operating status of the laser.
- Contain a beam switch or splitter, with an active indication of the direction of the optical power signal.

The system has been pre-adjusted at the factory. A prerequisite for the operation of a Class IV laser device is that any adjustment to the laser cannot expose anyone in the vicinity to laser radiation.

If the finished machine is to be used in a hand-held fashion, the device must shut off when released from the hand.

The manufacturer is to ensure the laser system is completely enclosed. This encapsulation must minimize the exposure to the eyes and skin so that no hazard can occur through direct or indirect laser radiation.

2.3 Requirements of the Integrator

A laser shutter must be integrated into the final product.

The finished machine must be equipped with an emergency stop switch and an have an interlock connected to the nominal hazard zone.

The power supply must be provided with a key switch and removable key to stop unauthorized use of the laser device.

2.4 Requirements of the Operator

The operator is obliged to notify the responsible parties at the company before first operation of the Class IV laser system. If the system is a mobile laser, then any change of location requires additional reporting.

Only authorized persons shall have access to the laser system, including places where the laser light is transported to. It is the responsibility of the Operator to adequately label and restrict access to these locations.

The nominal hazard zone (NHZ) should be kept as small as possible, and should not be operated across walkways or roads.

The laser should operate far above or below eye level.

If the Operator does not have the required laser safety expertise, consultation from a qualified Laser Safety Officer should be received before operating the laser. This will require:

- Incorporating safety monitoring where the laser beam is directed
- Working closely with a laser safety professional to ensure safe laser operation
- Ensuring that employees are instructed at least once per year in laser safety procedures

The certification of the Laser Safety Officer shall be renewed every two (2) years to keep their training up to current standards.

The Operator will provide each employee within the NHZ with adequate personal protective equipment (PPE) including laser safety glasses, flame resistant clothing, and other equipment as necessary.

Important Safety Note



Laser processing of many materials can create harmful gases, fumes, dust, mist or even explosive compounds.



Appropriate measures for removing harmful gases should be taken. Continuous monitoring should be performed where there is fire or explosion hazard.



Hazardous, flammable, or explosive substances which are not required for the process should be removed from the location of laser beam delivery.

If the laser is to be used outdoors, additional security measures must be taken. The laser beam can affect a very large area. It is important to ensure that:

- The NHZ is sufficiently limited and labeled
- The laser beam is contained
- There are safety stops implemented at the end of the effective range of the laser beam
- The field of view available to the laser beam is sufficiently limited
- That the laser system can be operated and stopped remotely

A backup power supply is required if power failure represents a potential risk to persons or property.

If the laser beam is directed by a robotic arm, provisions must be taken to ensure that no laser leakage occurs or uncontrolled laser radiation is released during movement of the arm.

Reflective surfaces should be removed from the beam path or covered with a suitable material

If major changes to the manufacturing process occur, the Laser Safety Officer must reassess the new risks presented by usage of the laser system.

The latest version of the operating and safety manual must be made available to all Operators

2.5 Residual Risks

Despite security measures incorporated into the laser system, there remain residual risks in the operation of all Class IV laser devices. The risks of a Class IV system should not be underestimated, and some major risks are listed below.

Primary Risks

The laser emits light the spectral range between 700-1600 nm, depending on specifications. The laser light in this range cannot be observed with the naked eye. There is significant risk to eye damage if proper procedures are not followed.

The laser beam may have a low divergence, which allows it to pass through the eye and be focused directly onto the retina. This can cause irreversible damage to the retina. Metallic surfaces, even those which appear dull and rough, can be highly reflective to infrared light. This presents an unpredictable risk, and these materials should be removed from the beam path.

The skin is transparent to infrared radiation. The risk of damage to the skin is highly dependent on the amount and location of IR radiation absorbed by the skin. Possible damage includes warming, burning, blistering, and splitting of the skin.

Secondary Risks



Material processing with laser radiation can cause hazardous gases and dusts to be emitted. Ventilation with a suitable filtering device should be used to reduce this risk. Where appropriate, a suitable supply of fresh air should also be provided.



Flammable substances can be ignited by laser radiation.



Explosive substances can be ignited by laser radiation.



To avoid hazards caused by electrical voltages and currents, only qualified personnel may operate the electronics.



Important: For damages which result from incorrect use or failure to observe the operating instructions, the User or Operator assumes full responsibility.

2.6 Risks from Incorrect Installation

Before powering on the laser system, all cables, hoses, and fibers should be properly secured. Failure to follow this instruction can result in module malfunction and damage to the system, persons, or property.

Always use undamaged cables and hoses. Defective cables, tubes, and fibers must be immediately reported and removed from service. During the exchange process, the laser system should not be used.

The optical cable can be damaged if incorrectly stored or used. It is the responsibility of the Operator to care for the optical delivery fiber.



All parts with a red wax seal or marked screws may not be removed. Removal of these items represents a risk of exposure to uncontrolled laser light, and will void the manufacturer's warranty.

2.7 Hazards Due to Laser System Malfunction

In the case of laser system malfunction, there can be damage to the laser system, persons, or other property. When a malfunction occurs, the laser system should be immediately shut down and secured in a way such that it cannot be operated again until serviced. The local support representative listed in section 1.2 should be immediately contacted.

2.8 General Safety Considerations

The laser system is designed with a three-step operational process. In order to operate, the interlocks (both hard and soft) must be cleared, the gate signal must be applied via the DB25 connector, and then the laser must then be enabled to begin emission.

3.0 System Setup Guide

This quick start guide describes the initial setup and bringing on-line of the laser. Depending on the model, the device is either water-cooled or air-cooled. It consists of a turnkey system with laser modules integrated into a 19" rack-compatible package. It is extremely important that all operating instructions be followed closely and carefully. The following instructions cover the powering, cooling, and optical aspects of the laser system.

3.1 System Overview - Identification of Parts

The Power Engine comes supplied with the following items:

- Power Engine System with integrated delivery cable
- Interlock connector (shorted for system testing)
- USB memory stick with Power Engine Controller software
- DB25 connector hood and solder connector for analog control
- Datasheet describing system specifications
- Quick-disconnect valves (for water-cooled systems only)
- Electrical terminal isolator



Front panel of PE1000 Power Engine System

Front Panel:

- The red Laser Enabled light will turn on when the laser is on.
- The green Power light will turn on when the power to the system is connected and switched on.



Rear Panel of PE1000 Power Engine System

Rear Panel:

- Input power terminal block with master On/Off switch
- Interlock: Amphenol DIN connector with 5V (Pin 3) and Interlock (Pin 1). Shorting these pins together satisfies the hardware interlock condition.
- USB connector for computer control
- DB25 connector for analog control. For test operation, short pin 11 to 13 and pin 12 to 25.
- Chilled water input manifold (water-cooled systems only)
- Trigger BNC (optional configuration)
- Ethernet connector with communications protocol toggle switch

3.2 Mechanical Features

The Power Engine is a 19" rack-mounted system is a fully-functioning laser system in a 2RU tall package. Mechanical drawings for the PE1000 are shown below:

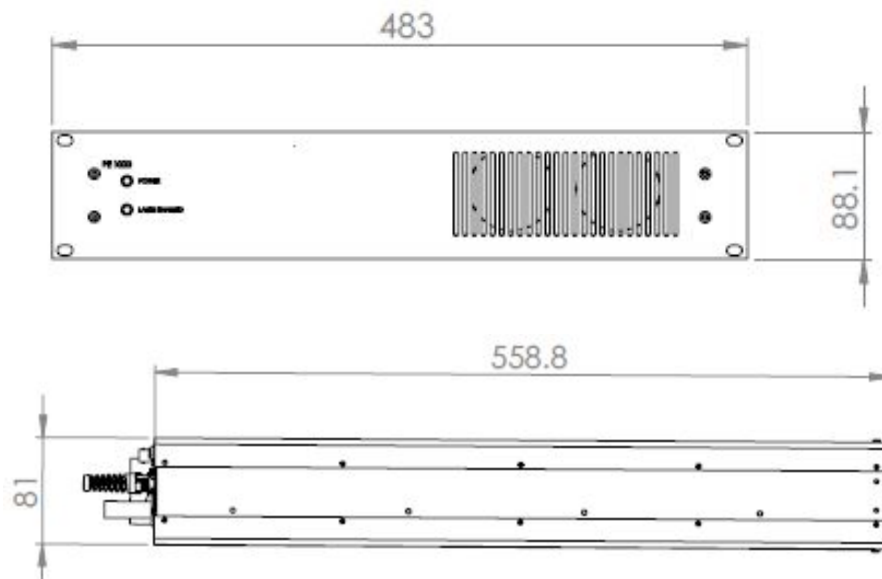

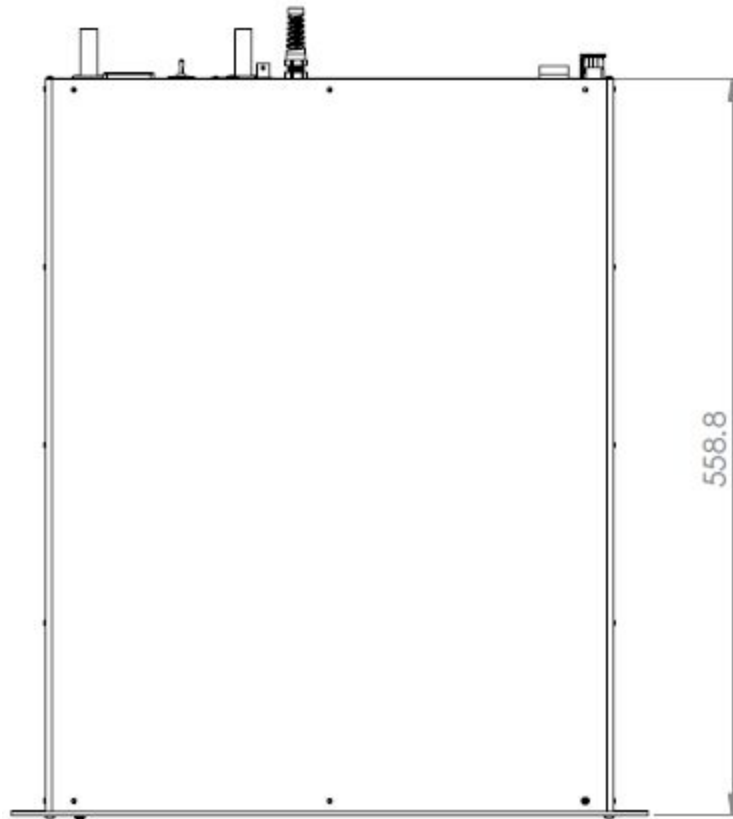

3.3 System Setup

1. Remove system from packaging, taking care to not exceed the minimum bend radius of the fiber. A table with guidelines for minimum bend radius is shown below:

Fiber Core (μm) NA = 0.22	Operational Minimum Bend Radius (mm)	Storage Minimum Bend Radius (mm)
105	25	22
200	30	25
400	75	65
600	115	100

2. Attach the interlock and DB25 connectors. Shorted testing versions can be used for testing purposes, but should not be present in the final system. To test, short pins 11 and 13 on the DB25 connector, and pins 1 and 3 on the interlock.
3. Connect water lines to the water inlet and outlet pipes using the provided quick disconnect fittings. See Section 4.4 for additional information.
 - a. De-mineralized water should be used when possible. Dark-colored hoses minimize risk of algae formation. Under standard, moderate-usage conditions, no additives must be added to the water. Please follow the specifications listed

in Section 4.6. If using a water chiller, fill coolant to the required level, as indicated on the chiller. After the hoses are connected and the coolant reservoir is filled, a water connection can be established. The pressure drop across the laser device should not be greater than 5 PSI.

- b. Turn on the chiller or water supply only after the entire water cycle is closed and inspected. Once on, be sure to carefully examine the system for any leaks.
 - c. The cooling water should be set to 17°C. If the laser is being operated in a hot and humid environment, there is a risk of water condensing on the module. If this is the case, the temperature should be increased slightly so that condensation does not occur.
 - d. Water flow rates are specific to the system configuration. Specifications should be closely adhered to, and can be found on the datasheet shipped with the system.
4. Inspect the end face of the delivery fiber. The end face should be protected at all times while the system is inactive, and should be inspected frequently in between operations.
 5. Connect the main power line to the terminal block. The power input voltage must match the input specifications listed on the unit. The exact input power specifications are unique to the system, and can be found on the accompanying datasheet or on the unit itself, listed near the power terminal block.
 6. Before turning on main power, the system should be inspected for any water leaks or loose connectors.
 7. Insert the USB memory stick into the control computer (not included), and copy the software into the directory of your choice.
 8. Attach a USB or Ethernet cable from your computer to the Power Engine. Depending on your operating system and configuration, you may need to install the device driver manually. This file is contained on the USB memory stick, and details regarding installation can be found in Appendix A.
 9. Open the controller software executable (OEI Amp Ctrl.exe) to run the Power Engine Controller software.

The laser system is now ready for normal operation.

4.0 System Operation

It is the responsibility of the Operator to ensure that all interlocks are working correctly and that any and all safeguards are in place to protect the Operator and any personnel in the effective area.



The laser system should not be put into service until all of the safety requirements have been fulfilled.

4.1 Control Interface - Software

4.1.1 Installation

The software will run on 32- or 64-bit versions of Windows. Windows 7 or later is recommended. Microsoft .NET version 4.6.2 or later is required for software operation.

1. Run the installation file from the USB drive. (LaserCtrl_Installer 5_X_X_X.MSI)
2. Follow all prompted instructions, and select whether or not Arduino driver installation is necessary. If this is your first time installing the program, the Arduino driver will be necessary to connect to the laser controller.
3. Once installation is complete, you are ready to run the program and connect to your laser controller.

4.1.2 Software Diagram

The screenshot displays the Optical Engines software interface with four main sections highlighted by red boxes and labeled A, B, C, and D.

Section A: Laser Controllers

Serial Num	Interlock	Pilot	Status	Set Point	Power	Temp
3120	Clear	<input type="checkbox"/>		0.0 : %	0.00 W	-94.89 °C
Group Ctrl	Clear	<input type="checkbox"/>		0.0 : %	0.00	-94.89 °C
3067	Clear	<input type="checkbox"/>		0.0 : %	0.00 W	-94.89 °C
3068	Clear	<input type="checkbox"/>		0.0 : %	0.00 W	-94.89 °C

Section B: Control

0.00 W The laser cannot be enabled right now. Global: The safety interlock is active.

Control External Control

Interlock Status

Clear Interlock

Section C: Laser Diodes

Name	Status	Set Point
PreAmp 1	<input type="checkbox"/>	10.70 : A
PreAmp 2	<input type="checkbox"/>	12.20 : A
Output Power	<input type="checkbox"/>	0.0 : %
Pump 1	<input type="checkbox"/>	0.00 : A
Pump 2	<input type="checkbox"/>	0.00 : A
Pump 3	<input type="checkbox"/>	0.00 : A
Pump 4	<input type="checkbox"/>	0.00 : A
Pump 5	<input type="checkbox"/>	0.00 : A

Section D: Sensors

Name	Value
LD Temp	-94.89 °C
Case Temp	-93.32 °C
Stage0 Input	3917 mW
Stage1 Input	3563 W
Stage2 Input	3335 W
Reverse Power	3094 W
Analog Input	0.0000 mV
Scatter Detected	0 X

- The Laser Controllers area will show all of the controllers currently connected, along with an abbreviated description of the status of each one. This area will also show any groups which have been designated, and allow you to switch to detail view of any controller. Detail view unlocks the following areas.
- The Control area allows for operation of general parts of an individual unit. Here, the interlock status can be observed and cleared, along with toggling External Control and the Pilot laser, when available.
- The Laser Diodes area shows detailed information regarding the status of each stage and diode in a single controller.
- The Sensors area gives detailed information on every sensor connected to a controller, including name, status, and limit when applicable.

- E. The Status area shows information on the status of the laser, the current output power, and any current errors which are preventing the laser from being enabled.

4.1.3 Software Operation

The software interface for the Power Engine is designed to be an intuitive, fully-detailed method for controlling systems. The following instructions will take the reader through normal operating conditions, along with addressing some of the potential problems encountered.

4.1.3.1 Connecting

Follow these steps to connect to your laser system(s):

1. Open the software by opening the executable file (OEI LaserCtrl.exe)
2. Select the laser(s) you wish to control on the “Connect?” column checkbox.

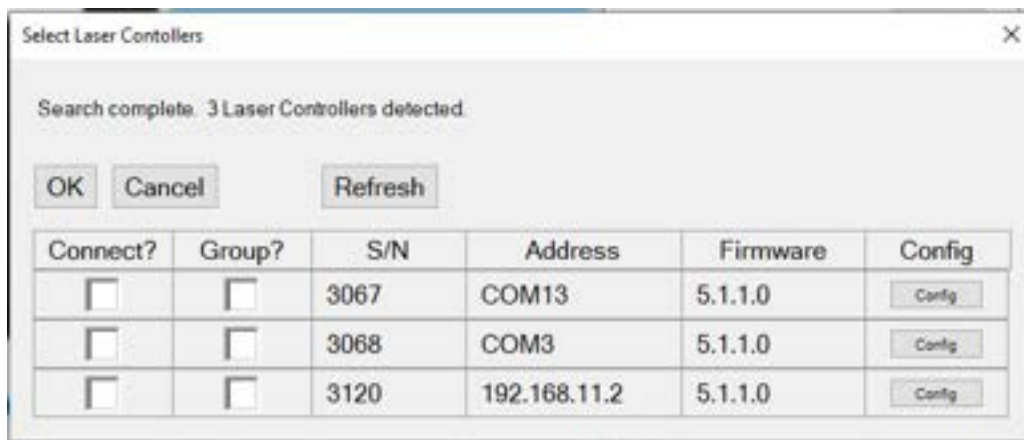

3. Click the “OK” button.

The selected devices will now be connected to the software for the current session. The Laser Controller software also allows for the grouping of devices for a single unified control covering multiple laser systems. In order to activate this feature, simply follow the above procedure as normal, while also clicking the appropriate checkbox in the “Group?” column for those systems you wish you group.

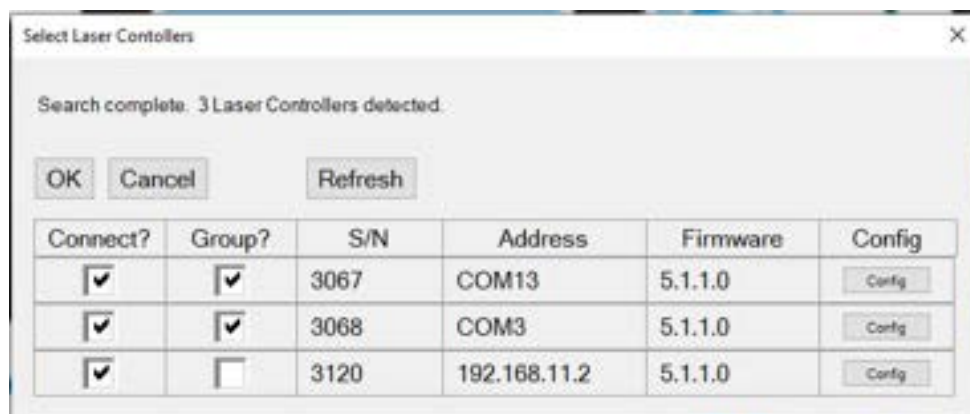

4.1.3.2 Main GUI

Once connected, the GUI will appear as shown below:



The screenshot shows the Optical Engines software interface. At the top, there are menu options: 'Connections', 'Tools', and 'Uptime'. The main title 'Optical Engines' is displayed in the top right. Below the menu is a section titled 'Laser Controllers' containing a table with the following data:

Serial Num	Interlock	Pilot	Status	Set Point	Power	Temp
3120	Clear	<input type="checkbox"/>	<input type="checkbox"/>	0.0 %	0.00 W	-94.89 °C
Group Ctrl	Clear	<input type="checkbox"/>	<input type="checkbox"/>	0.0 %	0.00	-94.89 °C
3067	Clear	<input type="checkbox"/>	<input type="checkbox"/>	0.0 %	0.00 W	-94.89 °C
3068	Clear	<input type="checkbox"/>	<input type="checkbox"/>	0.0 %	0.00 W	-94.89 °C

This view gives a brief overview of each laser controller connected to the system. The interlock, pilot, enable, and set point status are all shown and adjustable. The output power, and laser diode temperature are also displayed. If a group has been defined, the Set Point column for the group will show and control all lasers in the group. The temperature displayed will be the highest laser diode temperature in the group.

Clicking the eye symbol on any individual diode will bring up the detail view for that individual unit, as shown below.

Laser Controllers

Serial Num	Interlock	Pilot	Status	Set Point	Power	Temp
3120	Clear	<input type="checkbox"/>		0.0 : %	0.00 W	-94.89 °C
Group Ctrl	Clear	<input type="checkbox"/>		0.0 : %	0.00	-94.89 °C
3067	Clear	<input type="checkbox"/>		0.0 : %	0.00 W	-94.89 °C
3068	Clear	<input type="checkbox"/>		0.0 : %	0.00 W	-94.89 °C

0.00 W

The laser cannot be enabled right now.
Global: The safety interlock is active.

Control

External Control

Interlock Status

Clear Interlock

Laser Diodes

Name	Status	Set Point
PreAmp 1	<input type="checkbox"/>	10.70 : A
PreAmp 2	<input type="checkbox"/>	12.20 : A
Output Power	<input type="checkbox"/>	0.0 : %
Pump 1	<input type="checkbox"/>	0.00 : A
Pump 2	<input type="checkbox"/>	0.00 : A
Pump 3	<input type="checkbox"/>	0.00 : A
Pump 4	<input type="checkbox"/>	0.00 : A
Pump 5	<input type="checkbox"/>	0.00 : A

Sensors

Name	Value
LD Temp	-94.89 °C
Case Temp	-93.32 °C
Stage0 Input	3917 mW
Stage1 Input	3563 W
Stage2 Input	3335 W
Reverse Power	3094 W
Analog Input	0.0000 mV
Scatter Detected	0 X

The output power of the selected controller is shown in the upper left corner of the detail view. Any relevant status messages will be displayed in this same area. To the top right, the control area shows the status of the interlock, external control mode, and the pilot laser (if available).

The Interlock status will show up as Red, Yellow, or Green

1. Red: The external interlock circuit is open. The laser cannot be enabled until this circuit is closed. The Clear Interlock button is disabled, and cannot be activated.
2. Yellow: The external interlock circuit is closed, but the “soft” interlock is still enabled. This soft interlock can be cleared by clicking the “Clear Interlock” button.
3. Green: The laser is ready to be enabled.

The External Control checkbox at the upper right indicates whether or not the laser is under the control of external signals via the DB25 connector on the rear panel. If so, all GUI controls will be grayed out and the software can only be used to monitor the laser status. To return to GUI control, remove the checkmark from this box.

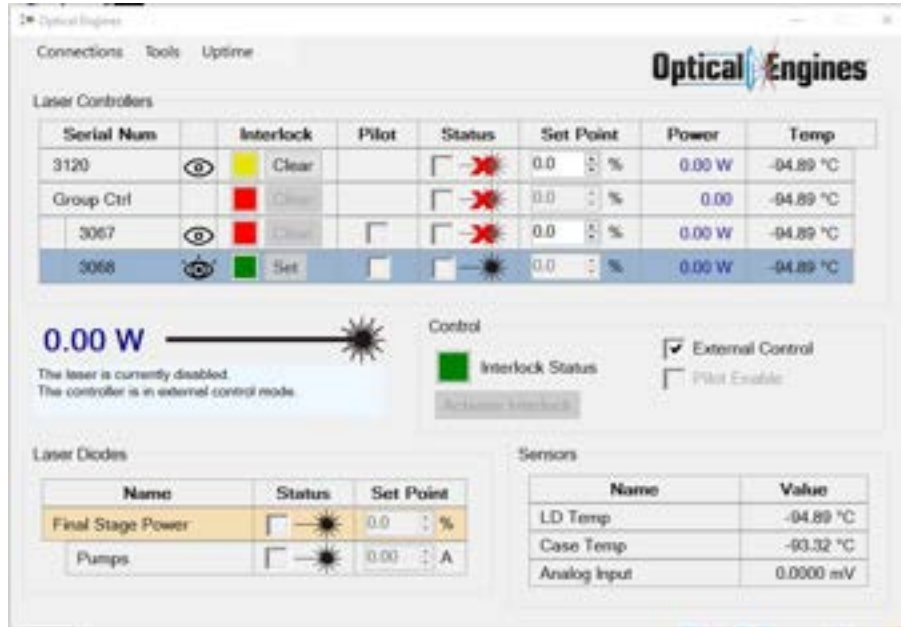

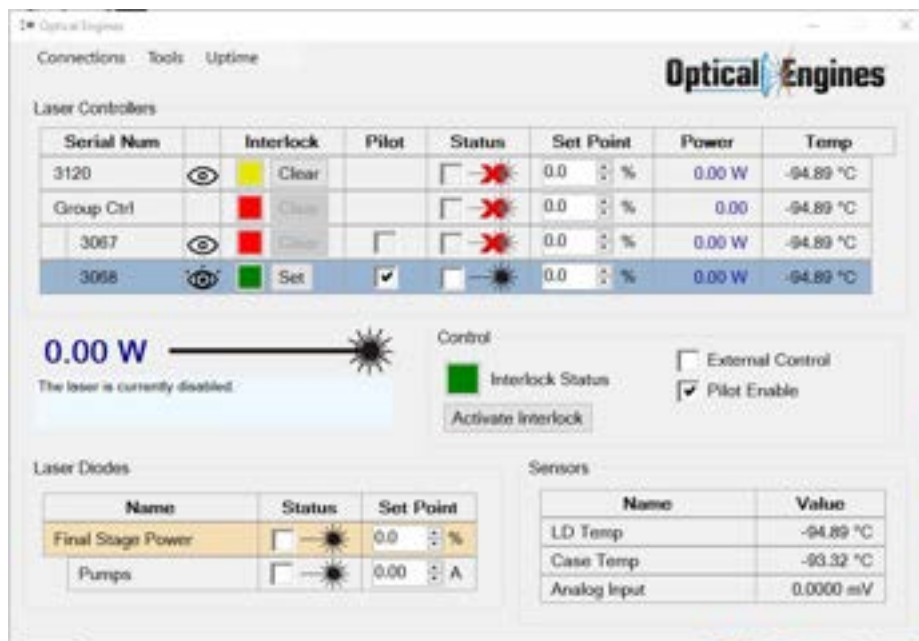

If the system is equipped with a pilot laser, clicking the “Pilot Enable” box will turn on the pilot and a check mark will appear in the Pilot Enable box. This feature will be grayed out if the interlock circuit has not been cleared.



The Laser Diodes list has three columns:

1. Name: The name for the laser diode to distinguish between one another on systems with multi-diode configurations.
2. Status: This checkbox enables or disables the laser diode(s). The symbol indicates the current status of the laser diode(s). Hovering the mouse over the symbol will display a useful tooltip message.
3. SetPoint: The current set point for the laser diode(s). Hovering the mouse over this value will display the maximum current allowed as a tooltip. The highlighted row will control all tabbed rows below it; in the shown example “Final Stage Power” will control “Pump 1” through “Pump 14.”

The status column symbols are defined as follows:

-  Laser symbol with a red X indicates that an error exists on this channel, which must be resolved before the laser diode(s) can be enabled. The tooltip will describe the error, and details on errors can be found in section 4.1.4.
-  Black laser symbol indicates that all errors on this channel have been cleared, and the laser diode(s) are ready for operation. The laser is currently off.
-  Red laser symbol indicates that the channel is currently on.

The output power can be controlled in two different ways. The first is to change the Set Point individually for each channel. These values directly control the applied current to the laser diode(s) in Amperes (A). The arrows will adjust the Set Point in increments of 0.01 A. The other method is to change the Set Point in the highlighted row, to control all laser diodes in the tabbed group below it. This controls the output power as a percentage of the total available. The arrows will adjust the value in increments of 0.1%. This highlighted row also makes use of a linearization algorithm to provide an actual percentage of maximum output power. The values for Amperes are not linear, and will be automatically set such that the overall output is the correct percentage of maximum. For example, if the maximum power of the system is specified as 1100 Watts, setting the highlighted row to 50% will yield an output of 550 W. Setting the current to half of the maximum will not yield the same output power. These values can all be adjusted while the laser is inactive, and changes will take place when the channels are enabled.

Channels can be enabled individually by checking the Enable checkbox in the Status column. Checking the Enable checkbox on the highlighted row will enable all laser diodes in the tabbed group below it. These checkboxes will be grayed out if there is an error which prevents the channel from being enabled, and tooltip on the symbol will describe the error.

The sensor table shows the value of any sensors equipped with the unit. Certain sensors have a threshold, over which the system will shut down. This value can be seen by hovering the

mouse over the current sensor value. As an example, the threshold LD Temp value is generally 40°C, over which the system will shut off. This example should only occur with a failure of the cooling system.

4.1.3.3 Manage Laser Uptime

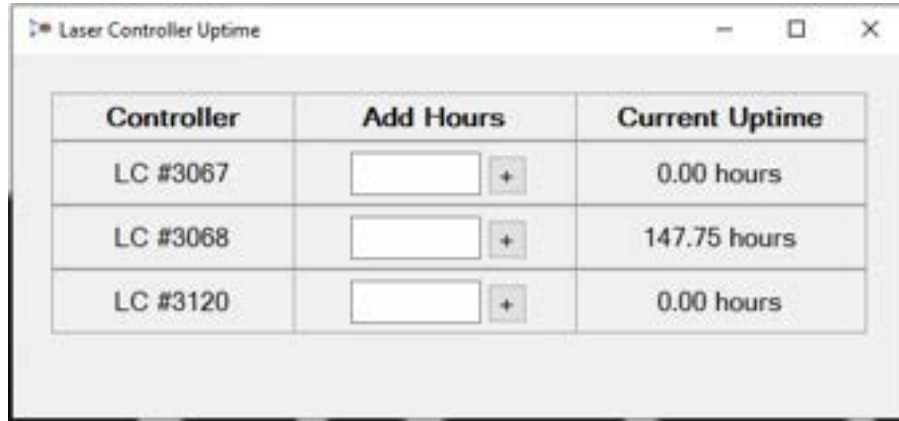

Controller	Add Hours	Current Uptime
LC #3067	<input type="text"/> +	0.00 hours
LC #3068	<input type="text"/> +	147.75 hours
LC #3120	<input type="text"/> +	0.00 hours

Clicking the “Uptime” menu option from the main GUI will open the Uptime Manager. This window displays the current uptime for each laser controller with the option to add hours. The controller’s serial number is shown on the left side and the current measured uptime on the right. Measured uptime has a resolution of 0.25 hours.

Adding hours has a resolution of 1 hour. Enter the desired amount of hours to add to a controller in the Add Hours text box, then click the “+” to add those hours; the Current Uptime will update automatically if the addition is successful. If the amount entered is not a positive integer, the add will fail and the text will turn red until the number is cleared.

Note: Adding uptime exists only to bring old (firmware version <5.1.3) systems up-to-date.

4.1.3.4 Update Firmware/Configuration

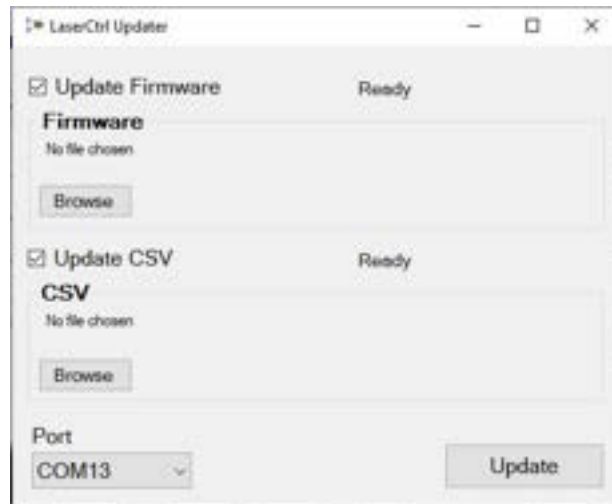

Clicking the Tools > Update menu option from the main GUI or the Config button from a controller in the connections window will open the Laser Ctrl Updater. This interface allows the user to flash the firmware and update the configuration of a laser controller. If both firmware and CSV updates are selected, the firmware update will happen before the CSV update.

Each update is enabled by the check box above the file selection area. If the window is opened from the main GUI, the firmware update will be checked and CSV unchecked. If opened from a Config button, CSV will be checked and firmware unchecked.

Click an update's Browse button to select the file for that update. Firmware updates allow .hex files and CSV updates allow .csv files. Once the appropriate files have been selected, ensure the port selection is correct as follows:

1. If opened from a Config button in the connections window
 - a. The port/address of the controller whose Config was clicked will be automatically selected.
 - b. All available controllers (and their port/address) will still be shown in the connections window, so you can manually select the port for any other controller.
2. If opened from the main GUI
 - a. No port will be automatically selected and the connections window will not be visible
 - b. Open Device Manager from the start menu and navigate to Ports. Look for the COM port that says Arduino Mega 2560 and select it in the Laser Ctrl Updater.

Once all desired updates are checked, files are selected, and port is selected, click Update.

Note: Updating firmware is only available over a serial port connection.

4.1.4 Ethernet Connectivity

The Power Engine software is set up to accommodate Ethernet connectivity, which is recommended in the case of controlling many units simultaneously. The systems are set to DHCP by default at the factory, so a router with this feature enabled will be required to connect properly.

4.1.5 Software Errors

Any errors which occur will appear in the software with an explanation. An error box below the output power reading will describe the highest-level error the system is experiencing. In most cases an error will prevent the laser from being enabled. If a serious error occurs during operation, some or all of the laser diodes will be shut down and a pop-up message will explain the error. An example of an interlock error is shown below:



The following list enumerates the possible laser controller errors which may be reported. If the laser is on when one of the following errors occurs, the laser will be turned off automatically, as indicated by the “Turn Off Action.” The different categories of actions are listed below:

- *Laser*: The entire system is shut down.
- *Final Stage*: The final stage is shut down. This is the same as *Laser* for a non-amplifying system.
- *Stage*: The stage containing the LDD reporting an error will be shut down, along with all stages downstream. This is the same as *Laser* for a non-amplifying system.
- *No*: The error does not affect the operating status of the laser.
- *Depends*: The specific turn off action depends on the device seeing the error.

The appropriate error will show up as a tooltip when the mouse hovers over any laser symbol with a red X.

Error Message	Turn Off Action	Solution
The safety interlock is active.	Laser	Make sure the external safety interlock circuit is closed. Click “Clear Interlock” button.
Unable to communicate with the controller.	Laser	Check the communications cable, and reconnect to the system. If the laser controller has received no communication from the software for a period of time and is not in External Control Mode, the laser will be shut down. This error is unlikely to be seen in the GUI, as there is no way to communicate the error to the software.
The reverse power limit has been exceeded.	Final Stage	The reverse power protection circuit has shut off the laser to protect itself from damage due to reflected light. Modify your setup to reduce reflected power.
The temperature limit has been exceeded.	Depends	A temperature sensor has detected a temperature which exceeds the error threshold for that sensor. Note the sensor which observed the error and contact technical support.
Insufficient optical input power.	Stage	This error will only occur for fiber amplifier systems. If insufficient input power is observed, the laser diode pumps cannot be safely enabled. Check optical input power and contact support.
The laser diode has	Stage	The laser diode temperature has exceeded

overheated.		the limit. Check air/coolant flow, and contact support if the problem persists.
The optical input power has dropped below the required level.	Stage	This error will only occur for fiber amplifier systems. It is nearly identical to “Insufficient optical input power” except that the laser was enabled when the input power was lost. The protection circuit has disabled the pump diodes very quickly to avoid system damage.
The previous amp stage needs to be enabled first.	No	Only applies to multi-stage systems. The laser diodes in previous stages must be enabled before following stages can be enabled.
The following amp stage needs to be disabled first.	No	Only applies to multi-stage systems. The laser diodes in following stages must be disabled before previous stages can be disabled.
A sensor has detected a condition outside the normal range.	Depends	The value of a sensor has exceeded the error threshold. The action to resolve the condition depends on the type of sensor.
A sensor has detected an unexpected change.	Depends	The value of a sensor has exceeded the rate-of-change threshold. The action to resolve the condition depends on the type of sensor.

If a latched sensor error appears (such as an over-temperature situation) the red sensor value should be double-clicked to clear it. Note that this does not prevent the problem from happening again immediately, if the problem has not been remedied.



The following errors exist, but should never be encountered during normal operation. If any of these errors are seen, the unit should be fully powered off and the electrical input power should be disconnected. Normal operation should not resume until technical support has been contacted.

Error Message	Turn Off Action	Solution
Could not adjust amps on an amps-locked laser diode.	No	The software has a bug. Contact technical support.
Command not allowed in external control mode.	Laser	The software has a bug. Contact technical support.
The DAC circuit has failed.	Laser	The controller has an electronics problem. Contact technical support.
The laser enable indicator circuit is malfunctioning.	Laser	The controller has a problem resulting in an inconsistent state. Contact technical support.
The controller is not properly initialized.	N/A	The controller has a problem with the on-board memory. The system will not operate; contact technical support.
A bad argument was sent to the controller.	No	The software has a bug. Contact technical support.
An unknown error has occurred.	No	The software has a bug. Contact technical support.
Command is not supported for this system.	No	The software has a bug. Contact technical support.

In addition to the Laser Controller errors, these additional errors may be encountered when attempting to connect the software.

Error Message	Solution
Connect Failed. No response from Laser Controller.	Ensure you have selected the correct COM port from the drop-down list. Unplug the USB/Ethernet cable and turn off power to the system. Turn the power back on and attempt to connect. If a COM port does not appear in the drop-down list, you may need to install the device driver.

<p>Connect Failed because the firmware on the controller is incompatible with this software. This software version = ##### Controller firmware = #####</p>	<p>Ensure you are using the software version that came with your product. The version number of the software folder should match up with the version number located on the datasheet. If multiple systems have been purchased, each system should only be run with the software version that were found on the USB drive that came with the system.</p>
<p>Connect Failed because configuration data is corrupted.</p>	<p>Contact technical support.</p>
<p>Connect Failed because there was a problem reading the configuration data.</p>	<p>Contact technical support.</p>
<p>A serious optical problem has been detected; continued operation of the laser is not allowed.</p>	<p>Laser is locked in disabled mode; contact technical support.</p>

4.2 Control Interface - Analog Access (DB25)

The system can be controlled via the DB25 connector and will respond to external analog commands when in this mode. The system may have been configured to start in external control mode by default, depending on customer specification.

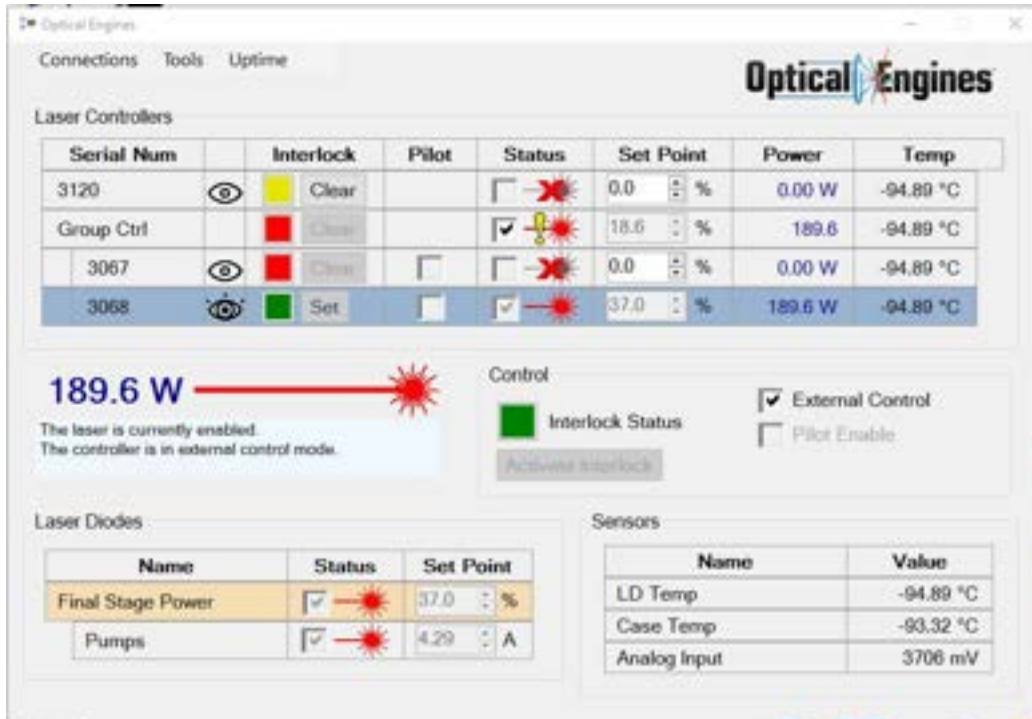

The screenshot displays the Optical Engines control interface. At the top, there are menu options for 'Connections', 'Tools', and 'Uptime'. The main section is titled 'Laser Controllers' and contains a table with the following data:

Serial Num	Interlock	Pilot	Status	Set Point	Power	Temp
3120	Clear		Off	0.0 %	0.00 W	-94.89 °C
Group Ctrl	Clear		On	18.6 %	189.6	-94.89 °C
3067	Clear		Off	0.0 %	0.00 W	-94.89 °C
3068	Set		On	37.0 %	189.6 W	-94.89 °C

Below the table, a large display shows '189.6 W' with a red laser icon and the text: 'The laser is currently enabled. The controller is in external control mode.' To the right, the 'Control' section includes a green 'Interlock Status' indicator, an 'Activate Interlock' button, and checkboxes for 'External Control' (checked) and 'Pilot Enable' (unchecked).

The bottom section is divided into 'Laser Diodes' and 'Sensors'.

Laser Diodes:

Name	Status	Set Point
Final Stage Power	On	37.0 %
Pumps	On	4.29 A

Sensors:

Name	Value
LD Temp	-94.89 °C
Case Temp	-93.32 °C
Analog Input	3706 mV

In the middle left-hand side of the GUI, a checkbox labelled “External Control” will show whether or not the system is in external control mode. In this example, the analog input has been used to increase the Output Power to 37% of maximum. In external control mode, all GUI functions will be grayed out and unavailable, but all sensor values and output parameters can be monitored.

An analog input signal of 0-10V will adjust the Output Power on a linearized scale from 0-100%. **Note:** individual pump lasers cannot be controlled in external control mode.

The operating modes of the Power Engine are designed to cover a wide range of applications and requirements.

CW Mode without Gate:

The laser system can be operated in CW mode by holding the gate signal high at 24V and switching the laser diodes on and off with the laser enable signal via the I/O interface. A variable delay of up to 3ms will occur before the laser diode responds to a change in the enable signal.

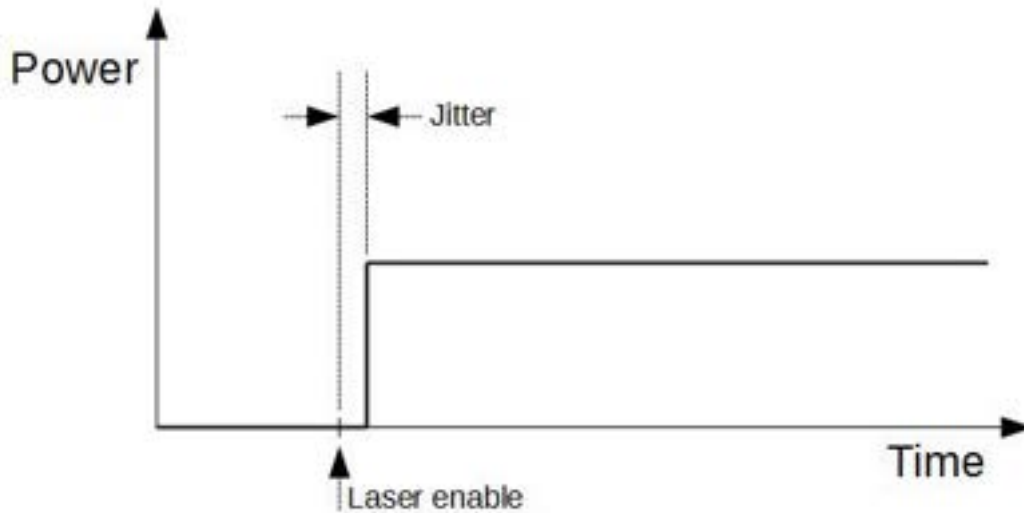

Laser Operation with Gate:

The laser can also be operated with a gate signal, which can activate the current from an external source with a nearly jitter-free time delay of <math>< 50\mu\text{s}</math>. The system will have the laser current already enabled and the analog signal set at the desired power level.

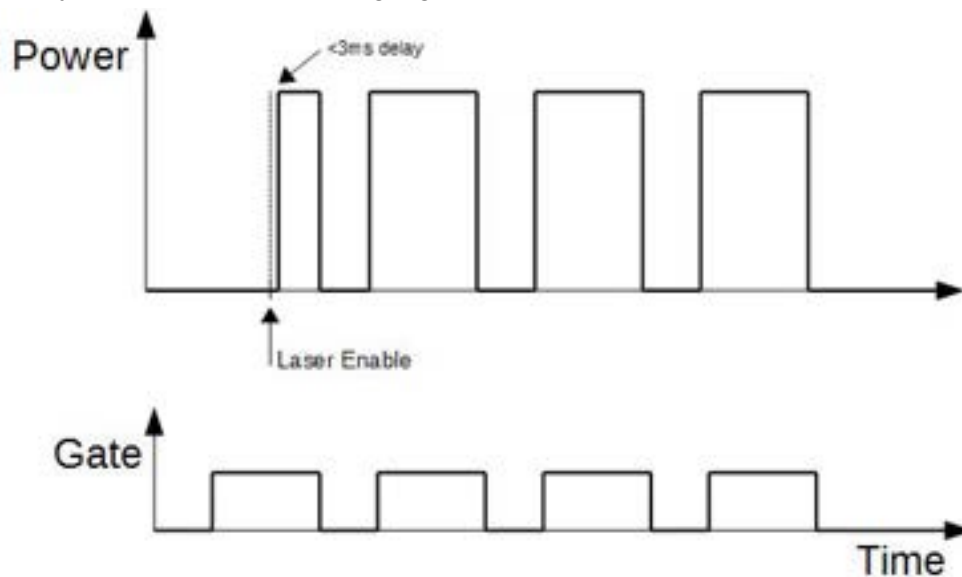

The following table shows the pinout for the DB25 connector on the rear panel of the unit. Please refer to this table when operating the unit in analog control.

Pin	Name	Type	Meaning	Remarks
1	Analog In	Input	Analog input, 0-10V	Sets laser power
14	Ground		Analog ground	
2	Laser Enable Input	Input	Laser Enable = 24V, Laser Disable = 0V	Enables laser; gate must at +24V
15				
3	Error Clear	Input	Error reset = 24V	Edge triggered
16				
4				
17	Error	Output	Error out = 24V	Collective error value for all errors
5				
18	Laser Enable Out	Output	Laser enable out = 24V	
6				
19	Remote	Output	Analog control enabled = 24V	
7	Pmonitor	Output	Laser monitor output, 0-5V	Linear to laser output, <3ms response
20	Ground			
8				
21	Ground			
9	Ready	Output	System ready = 24V	
22	Pilot Enable	Input	Pilot laser enable = 24V	Enables pilot laser
10	Pilot Out	Output	Pilot laser on = 24V	24V output if pilot laser enabled
23				
11	Gate	Input	Laser current gate = 24V	Apply 24V to turn on laser. Reaction time <50us. Isolated to pin 12.
24				
12	Gate Return	Input	Isolated return for pin 11	Short to ground if not isolating gate
25	Ground			

13	24V Source	Output	Supply for control signals	10mA maximum
----	------------	--------	----------------------------	--------------

The following diagram shows a sample of wiring. If an isolated gate signal is not required, add a jumper from pin 12 to 25 in order to ground the gate return signal, as shown by the dotted line.

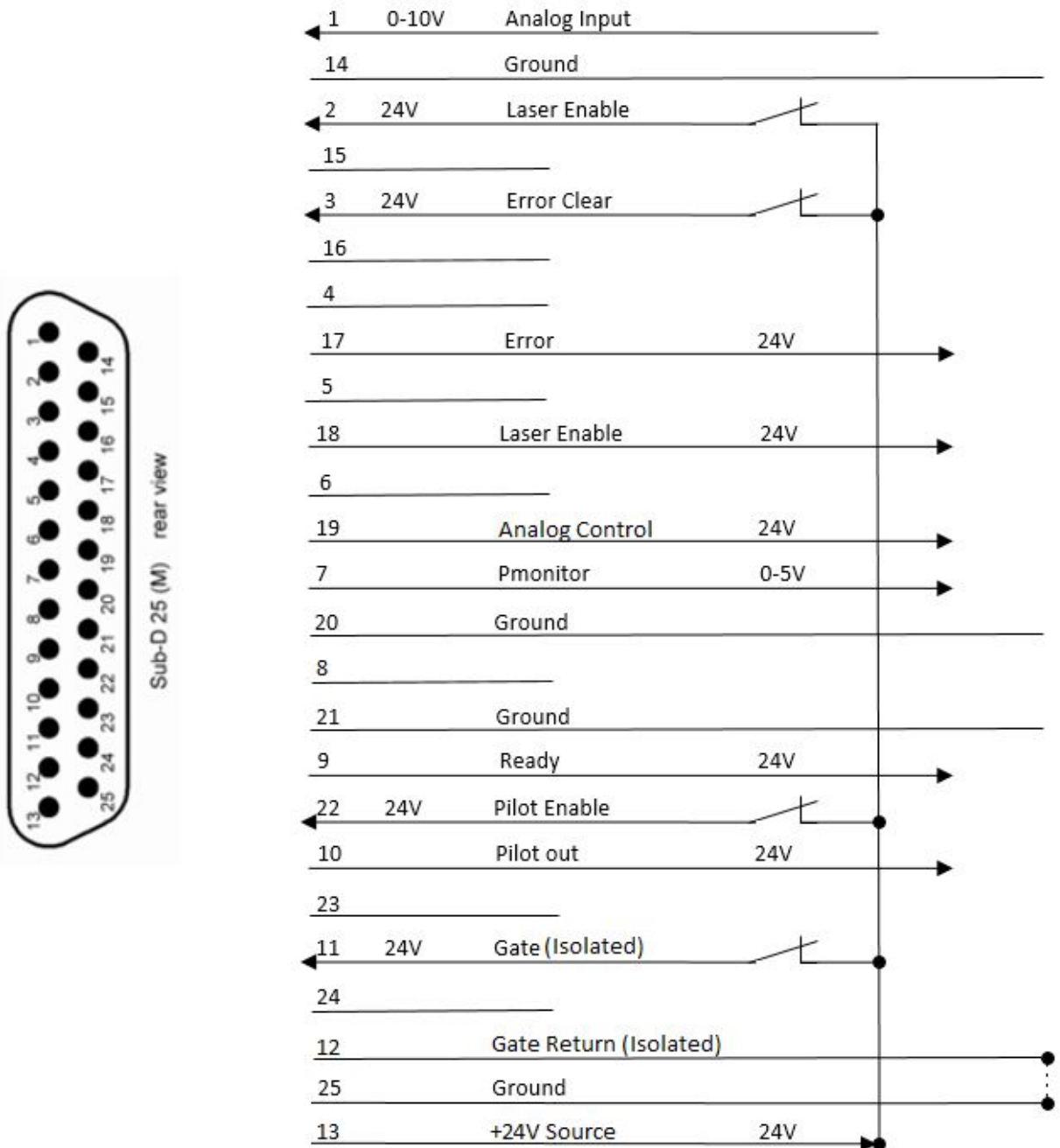

Upon startup, the error signal (pin 17) will be high (+24V) and will prevent laser operation. In order to begin laser operation:

1. Error clear (+24V to pin 3 for >10ms)
2. Ready signal (pin 9) should output +24V
3. Apply desired analog input signal (+0-10V to pin 1, <250us response time)
4. Enable laser (+24V to pin 2, <3ms response time)
5. Apply gate signal to turn on laser current (+24V to pin 11, <50us response time)

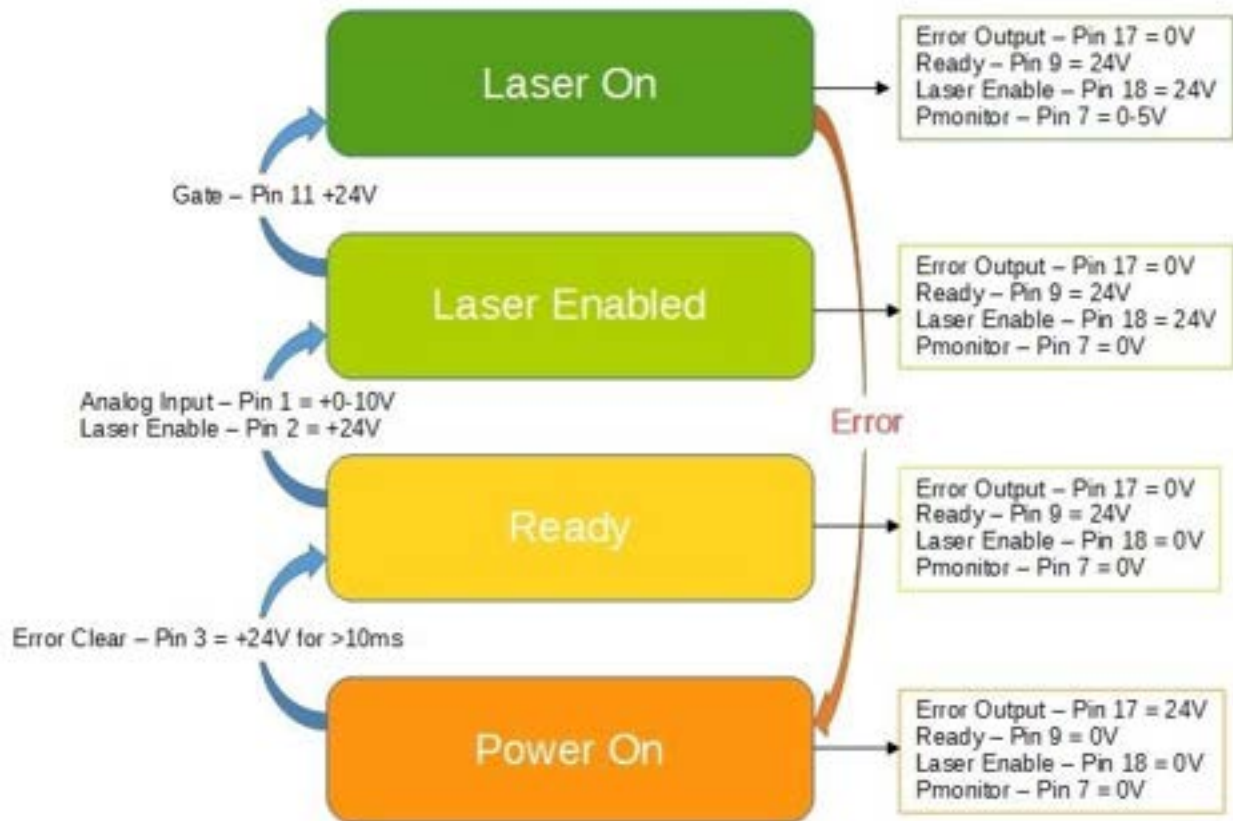

4.3 Control Interface - Serial Communication (RS-232)

Normal operation of the system is most easily accomplished with the supplied software. Custom software may be developed if more specialized behavior is required. This can be achieved using the RS-232 command interface described in Appendix B.

4.4 Water Cooling

Proper cooling for the system is crucial to maintaining top performance and reliability. Due to the materials used for the cooling plates, it is only recommended to use clean, filtered water for cooling. Contact the factory if environmental conditions require a different cooling medium.

For specific flow rate and temperature details, the Operator should consult the datasheet sent with the laser system.

The following water cleanliness specifications should be adhered to in order to prevent damage to the cooling system and laser. If the specifications are not followed, the warranty will be considered null and void.

	PCW Specification
Calcium	< 1.0
Magnesium	< 0.1
Sodium	< 1.0
Potassium	< 0.1
Ammonium	< 0.1
pH	> 7.1 to <7.5
Total Dissolved Solids (mg/ L)	< 10
Copper (as Cu²⁺)	< 0.2
Iron (as Fe³⁺)	< 0.2
Total Aerobic Bacteria (col/ml)	<0.01col/ml
Resistivity (kohm-cm)	30 ± 10

4.5 Fiber Care

The optical delivery fiber is an extremely sensitive component. To avoid damage to the device and injury to persons or property, the following points must be considered:

- The minimal bend radius of each fiber must be observed (see Section 3.3).
- Do not touch or contaminate the ends of the fiber.
- Keep the fiber dust caps in a safe and clean place in close proximity to the deployed laser system.
- The fiber dust caps should be installed at all times during transportation and storage.
- For SMA fiber caps, ensure that the caps are removed before the laser is operated.
- The fiber ends should be cleaned only using extreme caution.
- The fiber should be secured against falling.
- To prevent damaging the fiber during installation, the metal shaft should be touched to the coupling unit before inserting the fiber into the holder. The necessary connections should then be screwed in and secured.
- Extreme caution should be used if the optical cable is used in a wet or very hot environment. The laser should not be operated in a condensing environment. Humidity should not be allowed to condense on the fiber ends.
- The fiber should not be used if damage can be visually observed.
- Excessive force should never be used to assemble or disassemble the laser. If the fiber resists installation, the coupling unit and fiber should be inspected for damage or debris.
- The fiber should never be twisted, pinched, or kinked.
- There should always be sufficient slack in the fiber for a robot arm to have full range of motion without stressing the delivery cable.
- If an optical cable needs to be placed along a walkway, the cable should be stored in a solid shell, such as a pipe or conduit.

DANGER: The fiber should NEVER be handled while the laser is operating. Any adjustments or modifications to the fiber positioning or mounting should only be performed after fully shutting down the laser system. Failure to follow these instructions could expose the Operator or others to over 1000W of invisible laser radiation, causing significant damage to persons or property.



Appendix A - Command Index

A.1 - RS-232 Commands

Connection Parameters

The Power Engine can be accessed using a terminal program such as HyperTerminal or ZOC. To connect a PC to the laser system, connect the communications cable (USB or Ethernet) and direct the program to connect to the created COM port. The connection can be established using the following parameters:

- Baud Rate - 115200
- No parity
- 8 data bits
- 1 stop bit
- No hardware control

Important Control Points

In order to begin communications, the unit must receive the following characters: “}}}” three ASCII 0x7D. The controller will not respond to any commands until this sequence is received.

During normal operation, the controller will expect to receive a command at least once every 5 seconds. If this condition is not satisfied, the controller will shut off the laser and stop responding to commands until the sync bytes “}}}” are sent once again. This process is in place for safety reasons so that if communications are interrupted, the laser will not continue to operate uncontrolled.

Command Format

Most commands sent to the laser system will be in ASCII format. Some commands are available in binary format for high-speed communication; these commands are listed in Appendix B.2. All communication is preceded by a Command ID; ASCII commands will have Command ID values between 0-127, and binary commands will have values between 128-255.



ASCII Command Format

<Command ID>|<Param0>|<Param1>|...|<ParamN>}

Whitespace characters such as carriage return (\r), line feed (\n) and space are ignored. Parameters are separated by the vertical line '|', ASCII character 0x7C, and the command is terminated with a close curly brace '}', ASCII character 0x7D. The format of each parameter depends on the data type, and is specified in the command index below. All commands sent to the laser system will result in a response command reply, sent in the same format.

Command Index

The commands available to send to the laser system are listed below, along with the corresponding parameters, if applicable. The expected response is listed next, along with any applicable return parameters. Finally, an example command and response is listed to demonstrate usage and handling of the command.

Version

Description

Requests firmware version from the controller.

Send from Computer - Command ID 0

Syntax: 0}

Parameter Name	Data Type	Description
-	-	-

Receive from Controller - Command ID 0

Syntax: 0|Version}

Parameter Name	Data Type	Description
Version	uint32	The version of the firmware. When read in hex, each byte corresponds to the major, minor, release, and build version numbers. The software requires that the first two bytes are equal to the major and minor release version of the software. (e.g. software is version 4.2.3.0, the firmware must be 0x0402xxxx, with 'x' as any value.

Example:

Send Command	Receive Command	Explanation
0}	0 67175168}	The returned value is 04010300 in hexadecimal format. This corresponds to a firmware version of 4.1.3.0.

GetSerialNum

Description

Requests unit serial number.

Send from Computer - Command ID 1

Syntax: 1}

Parameter Name	Data Type	Description
-	-	-

Receive from Controller - Command ID 1

Syntax: 1|SerialNum}

Parameter Name	Data Type	Description
SerialNum	uint16	The serial number for the connected device.

Example:

Send Command	Receive Command	Explanation
1}	1 3007}	The return shows the connected device serial number as 3007.

Ack

Description

Acknowledgement response. This response is sent from the controller to acknowledge commands which have no return parameters. It is never sent by the user, only received.

Receive from Controller - Command ID 4

Syntax: 4|LaserError}

Parameter Name	Data Type	Description
LaserError	uint8	The error (if any) which occurred during command execution. Return value is 0 for successful execution. See definition of error codes for more details.

Example:

Send Command	Receive Command	Explanation
-	4 0}	The response indicates that no errors were encountered when executing the previous command.

LaserError

Description

This command is only sent from the controller, and not in response to any user commands. It is sent when one or more laser diodes have been turned off automatically by the controller in response to an error condition which has arisen. This command can be sent at any time during normal operation, and any custom software must be ready to handle this error at all times.

Receive from Controller - Command ID 6

Syntax: 6|LaserError|ComponentType|Index}

Parameter Name	Data Type	Description
LaserError	uint8	The error which caused the laser diode to shut down. See definition of error codes for more details.
ComponentType	uint8	The component type where the error code occurred. The possible values are: 255: Global (refers to entire laser system) 0, 1, 2: StageID (non-amplifier systems will only have Stage 0) 8: Sensor
Index	uint8	The index of the component where the error occurred. If Index is 255, then Index can be ignored. If ComponentType refers to a stage, a non-255 Index will give the index of the laser diode within the stage that caused the error. If ComponentType is a sensor, Index will refer to the index of the sensor which caused the error.

Example:

Send Command	Receive Command	Explanation
-	6 5 0 255}	This command is sent spontaneously in response to an error which occurs while the laser is in operation. The example indicates the problem is a low input signal on stage 0. The Index parameter in this example is irrelevant.

SetInterlock

Description

Sets the software interlock status. If the hardware interlock circuit is open, attempting to close the software interlock will fail.

Send from Computer - Command ID 9

Syntax: 9|Set}

Parameter Name	Data Type	Description
Set	bool	Send 0 to close the interlock, 1 to open it.

Receive from Controller - Command ID 4

Syntax: 4|LaserError}

Parameter Name	Data Type	Description
LaserError	uint8	The error (if any) which occurred during command execution. Return value is 0 for successful execution. See definition of error codes for more details.

Example:

Send Command	Receive Command	Explanation
9 0}	4 1}	Attempts to close the software interlock. Response indicates the hardware interlock is open, and the attempt has failed.

SetExtMode

Description

Sets whether the controller operates in external control mode or serial command (software GUI) control mode.

Send from Computer - Command ID 10

Syntax: 10|Set}

Parameter Name	Data Type	Description
Set	bool	Send 1 to put the system in external control mode, 1 to operate in serial command (software GUI) control mode.

Receive from Controller - Command ID 4

Syntax: 4|LaserError}

Parameter Name	Data Type	Description
LaserError	uint8	The error (if any) which occurred during command execution. Return value is 0 for successful execution. See definition of error codes for more details.

Example:

Send Command	Receive Command	Explanation
10 0}	4 0}	Attempts to set the device to external control mode. Response indicates OK status.

LDDSetAmps

Description

Changes the drive current for the specified laser diode.

Send from Computer - Command ID 8

Syntax: 8|StageIdx|LDDIdx|Amps}

Parameter Name	Data Type	Description
StageIdx	uint8	The ID of the stage containing the laser diode to adjust. This parameter is always zero for non-amplifier systems.
LDDIdx	uint8	The zero-based index of the laser diode to adjust.
Amps	float	The new set point for the laser diode in Amperes.

Receive from Controller - Command ID 4

Syntax: 4|LaserError}

Parameter Name	Data Type	Description
LaserError	uint8	The error (if any) which occurred during command execution. Return value is 0 for successful execution. See definition of error codes for more details.

Example:

Send Command	Receive Command	Explanation
8 1 0 2.5}	4 0}	Attempts to adjust the drive current of laser diode ID 0 on stage 1 to 2.5A. Response indicates OK status.

StageSetAmps

Description

Changes the set point for all laser diodes on the specified stage.

Send from Computer - Command ID 11

Syntax: 11|Stage|Amps}

Parameter Name	Data Type	Description
Stage	uint8	The ID of the stage to adjust. This parameter is always zero for non-amplifier systems.
Amps	float	The new set point for all laser diodes on the stage in Amperes.

Receive from Controller - Command ID 4

Syntax: 4|LaserError}

Parameter Name	Data Type	Description
LaserError	uint8	The error (if any) which occurred during command execution. Return value is 0 for successful execution. See definition of error codes for more details.

Example:

Send Command	Receive Command	Explanation
11 0 5.5}	4 0}	Attempts to adjust the drive current of all laser diodes on stage 0 to 5.5A. Response indicates OK status.

StageSetPowerPercent

Description

Sets the power values of all laser diodes on a stage sequentially, regardless of current set point. This function will use the linearization algorithm to provide an accurate percentage of maximum available output power.

Send from Computer - Command ID 18

Syntax: 18|Stage|Percent|Enable}

Parameter Name	Data Type	Description
Stage	uint8	The ID of the stage to adjust. This parameter is always zero for non-amplifier systems.
Percent	uint16	Set percentage of maximum power as a value 0-4096, with 4096 representing 100%.
Enable	bool	If false (0), all LDD's on Stage will be disabled before adjusting the set points of each LDD. Subsequent enables of the LDD's will cause them to turn on at the specified set point. If true (1), at least one LDD on Stage must already be enabled or the command will fail. This command will enable additional LDD's as necessary, but will not enable the first LDD if none are currently enabled.

Receive from Controller - Command ID 4

Syntax: 4|LaserError}

Parameter Name	Data Type	Description
LaserError	uint8	The error (if any) which occurred during command execution. Return value is 0 for successful execution. See definition of error codes for more details.

Example:

Send Command	Receive Command	Explanation
18 1 2047 1}	4 0}	Sequentially adjusts the set point of all laser diodes on stage 0 until 50% output power is achieved. Response indicates OK status.

LDDEnable

Description

Enables or disables an individual laser diode.

Send from Computer - Command ID 7

Syntax: 7|Stage|Percent|Enable}

Parameter Name	Data Type	Description
StageIdx	uint8	The ID of the stage containing the LD to enable. This parameter is always zero for non-amplifier systems.
LDDIdx	uint8	The zero-based index of the laser diode to enable.
Enable	bool	Set true (1) to enable to laser diode, false (0) to disable.

Receive from Controller - Command ID 4

Syntax: 4|LaserError}

Parameter Name	Data Type	Description
LaserError	uint8	The error (if any) which occurred during command execution. Return value is 0 for successful execution. See definition of error codes for more details.

Example:

Send Command	Receive Command	Explanation
7 2 4 0}	4 11}	Attempts to disable laser diode ID 4 on stage ID 2. Response indicates a bad argument, for example because stage ID 2 does not exist. The action fails.

StageEnable

Description

Sets the power values of all laser diodes on a stage sequentially, regardless of current set point. This function will use the linearization algorithm to provide an accurate percentage of maximum available output power.

Send from Computer - Command ID 12

Syntax: 12|Stage|Enable}

Parameter Name	Data Type	Description
Stage	uint8	The ID of the stage to modify. This parameter is always zero for non-amplifier systems.
Enable	bool	Set true (1) to enable the stage, false (0) to disable.

Receive from Controller - Command ID 4

Syntax: 4|LaserError}

Parameter Name	Data Type	Description
LaserError	uint8	The error (if any) which occurred during command execution. Return value is 0 for successful execution. See definition of error codes for more details.

Example:

Send Command	Receive Command	Explanation
12 1 1}	4 13}	Attempts to enable stage ID 1. Response indicates the action failed because a previous stage is disabled.

PilotEnable

Description

If present, enables or disables the pilot laser.

Send from Computer - Command ID 13

Syntax: 13|Enable}

Parameter Name	Data Type	Description
Enable	bool	Set true (1) to enable the pilot laser, false (0) to disable.

Receive from Controller - Command ID 4

Syntax: 4|LaserError}

Parameter Name	Data Type	Description
LaserError	uint8	The error (if any) which occurred during command execution. Return value is 0 for successful execution. See definition of error codes for more details.

Example:

Send Command	Receive Command	Explanation
13 1}	4 0}	Attempts to enable the pilot laser. Response indicates OK status.

GetGlobalState

Description

Requests all global state parameters.

Send from Computer - Command ID 14

Syntax: 14}

Parameter Name	Data Type	Description
-	-	-

Receive from Controller - Command ID 14

Syntax:

14|LaserError|ComponentType|Index|Interlock|IsLaserOn|IsPilotOn|ExtCtrlMode|IsAPCOn|StageCnt|SensorCnt|OutputPower}

Parameter Name	Data Type	Description
LaserError	uint8	The current error condition of the full system. See definition of error codes for more details.
ComponentType	uint8	The component type where the error (if any) occurred. See LaserError (ID 6) for more details.
Index	uint8	The index of the component where the error (if any) occurred. See LaserError (ID 6) for more details.
Interlock	bool	True (1) for an open hardware interlock, false (0) if closed. If LaserError indicates an interlock error but this parameter is 0, the software interlock is open and can be closed with SetInterlock (ID 9).
IsLaserOn	bool	True (1) if one or more laser diodes are active, false (0) otherwise.
IsPilotOn	bool	True (1) if the pilot laser is enabled, false (0) otherwise.
ExtCtrlMode	bool	True (1) if the unit is in external control mode, false (0) if the unit is in software GUI control mode.
IsAPCOn	bool	True (1) if Active Power Control is enabled, false (0) otherwise.
StageCnt	uint8	The number of existing stage objects. This value will not change.

SensorCnt	uint8	Number of existing sensor objects. This value will not change.
OutputPower	float	Current optical output power of the system in Watts.

Example:

Send Command	Receive Command	Explanation
14}	14 0 255 255 0 0 0 0 0 1 3 0.0}	Requests the global device state. First three parameters are the full LaserError, indicating no errors are currently present. Interlock = 0 indicates a closed hardware interlock circuit. IsLaserOn = 0 indicates that no laser diodes are currently active. IsPilotOn = 0 indicates the pilot laser is disabled. ExtCtrlMode = 0 indicates that the device is in software GUI control mode. IsAPCOn = 0 indicates that Active Power Control is disabled. StageCnt = 1 indicates that this system has one (1) stage. SensorCnt = 3 indicates that this system has three (3) sensor objects. OutputPower = 0.0 indicates that zero output power is detected, which would be expected when IsLaserOn = 0.

GetLDDState

Description

Requests the state parameters for the specified laser diode.

Send from Computer - Command ID 15

Syntax: 15|Stage|LDIdx}

Parameter Name	Data Type	Description
Stage	uint8	The ID of the stage containing the laser diode to query. This parameter is always 0 for non-amplifier systems.
LDIdx	uint8	The zero-based index of the laser diode to query.

Receive from Controller - Command ID 15

Syntax: 15|Error|IsEnabled|AmpsVal|Stage}

Parameter Name	Data Type	Description
Error	uint8	The error (if any) which occurred during command execution. Return value is 0 for successful execution. See definition of error codes for more details.
IsEnabled	bool	True (1) if the queried laser diode is enabled, false (0) otherwise.
AmpsVal	float	Set point of the laser diode in Amperes.
Stage	uint8	The ID of the stage containing the laser diode to query. This will always be 0 for non-amplifier systems.

Example:

Send Command	Receive Command	Explanation
15 0 1}	15 0 1 2.50 0}	Requests the state of laser diode ID 1 on stage 0. Response indicates no error condition, the laser diode is enabled, the set point is 2.50A, and the diode exists on stage 0.

GetSensorState

Description

Requests all sensor parameters.

Send from Computer - Command ID 16

Syntax: 16|SensorIdx}

Parameter Name	Data Type	Description
SensorIdx	uint8	The ID of the sensor to query.

Receive from Controller - Command ID 16

Syntax: 16|Err|Val}

Parameter Name	Data Type	Description
Err	uint8	The error (if any) which occurred during command execution. Return value is 0 for successful execution. See definition of error codes for more details.
Val	float	Current converted value of the sensor.

Example:

Send Command	Receive Command	Explanation
16 2}	16 0 23.00}	Requests the current value of sensor ID 0. Response indicates that no error is present and the current converted value of the sensor is 23.00

GetStageState

Description

Requests all stage state parameters.

Send from Computer - Command ID 17

Syntax: 17|Stage}

Parameter Name	Data Type	Description
Stage	uint8	The ID of the stage containing the laser diode to query. This parameter is always 0 for non-amplifier systems.

Receive from Controller - Command ID 17

Syntax: 17|Error|LDDCount|LDDEnabledCount|IsHwEnabled|AmpsPercent|PowerPercent}

Parameter Name	Data Type	Description
Error	uint8	The error (if any) which occurred during command execution. Return value is 0 for successful execution. See definition of error codes for more details.
LDDCount	uint8	The number of existing LDD's on the stage.
LDDEnabledCount	uint8	The number of currently enabled LDD's on the stage.
IsHwEnabled	bool	True (1) if the hardware protection circuit is currently allowing operation of the stage, false (0) otherwise.
AmpsPercent	uint16	Percentage of maximum current the stage is set to as a value from 0-4095 (100%)
PowerPercent	uint16	Percentage of maximum power the stage is currently set to as a value from 0-4096 (100%).

Example:

Send Command	Receive Command	Explanation
17 2}	17 0 2 1 1 3072 3359}	Requests the current state parameters of stage ID 2. Response indicates that no error is present, and that of two LD's on the stage, one is enabled. The hardware protection circuit is currently allowing operation. The stage is currently set to 75% of maximum current, and 82% of maximum power.

QueueStageEnable

Description

Queues the enable of the specified stage. This differs from StageEnable (command ID 12) in that you may turn on any stage regardless of preamp status. Turn on rules are still followed, so the action might not be immediately carried out. Successful execution should be checked afterwards with a GetStageState command.

Send from Computer - Command ID 23

Syntax: 23|Stage}

Parameter Name	Data Type	Description
Stage	uint8	The ID of the stage containing the laser diode to adjust. This parameter is always 0 for non-amplifier systems.
Enable	bool	Send true (1) to queue the enable of the specified stage, false (0) to queue the disable.

Receive from Controller - Command ID 4

Syntax: 4|LaserError}

Parameter Name	Data Type	Description
LaserError	uint8	The error (if any) which occurred during command execution. Return value is 0 for successful execution. See definition of error codes for more details.

Example:

Send Command	Receive Command	Explanation
23 0 0}	4 0}	Queues the disable of stage ID 0. Response is OK, though GetStageState should be called to verify that the stage was successfully disabled.

SensorClearError

Description

Clears the error from a sensor with latching enabled. Except for sensor type OutputPower, use 0 as the ClearCode parameter.

Send from Computer - Command ID 24

Syntax: 24|SensorIdx|ClearCode}

Parameter Name	Data Type	Description
SensorIdx	uint8	The ID of the sensor with the error to clear.
ClearCode	uint32	Except for sensor type OutputPower, use 0 for this parameter.

Receive from Controller - Command ID 4

Syntax: 4|LaserError}

Parameter Name	Data Type	Description
LaserError	uint8	The error (if any) which occurred during command execution. Return value is 0 for successful execution. See definition of error codes for more details.

Example:

Send Command	Receive Command	Explanation
24 4 0}	4 0}	Clears the error on sensor ID 4. Response is OK.

APCEnable

Description

Enables or disables Active Power Control, which actively adjusts laser power based on actual measured output power in order to achieve and maintain the desired set point.

Send from Computer - Command ID 27

Syntax: 27|Enable}

Parameter Name	Data Type	Description
Enable	bool	Send true (1) to enable APC, false (0) to disable.

Receive from Controller - Command ID 4

Syntax: 4|LaserError}

Parameter Name	Data Type	Description
LaserError	uint8	The error (if any) which occurred during command execution. Return value is 0 for successful execution. See definition of error codes for more details.

Example:

Send Command	Receive Command	Explanation
27 0}	4 0}	Disables APC. Response is OK.

SetAuxAnalogOut

Description

Sets the auxiliary analog output setting to the desired value. This feature is optional, and not available on all units.

Send from Computer - Command ID 28

Syntax: 28|SetPoint}

Parameter Name	Data Type	Description
SetPoint	float	Number which sets the analog output value to the requested value. The value is fully dependent on the individual system setup, and the datasheet should be consulted to determine the acceptable range of values.

Receive from Controller - Command ID 4

Syntax: 4|LaserError}

Parameter Name	Data Type	Description
LaserError	uint8	The error (if any) which occurred during command execution. Return value is 0 for successful execution. See definition of error codes for more details.

Example:

Send Command	Receive Command	Explanation
28 3015}	4 0}	Sets the value of the analog output to 3015. Response is OK.

SetAuxPWMOut

Description

Enables or disables pulse width-modulated output, which behaves similarly to an internal signal generator. This feature is optional, and not available on all units.

Send from Computer - Command ID 29

Syntax: 29|Enable|Period|Duty}

Parameter Name	Data Type	Description
Enable	bool	Send true (1) to enable PWM output, false (0) to disable.
Period	uint32	The period in microseconds (μs) of one cycle of PWM output. $\text{Period } (\mu\text{s}) = 1000000 / \text{Frequency (Hz)}$.
Duty	uint16	The duty cycle of the PWM output, from 0-65535 (100%).

Receive from Controller - Command ID 4

Syntax: 4|LaserError}

Parameter Name	Data Type	Description
LaserError	uint8	The error (if any) which occurred during command execution. Return value is 0 for successful execution. See definition of error codes for more details.

Example:

Send Command	Receive Command	Explanation
29 1 1000 6553}	4 0}	Enables the PWM output with a 1ms period and a duty cycle of 10%. Response is OK.

GetSystemOnTime

Description

Request system on time, reported in count of 15 minute intervals

Send from Computer - Command ID 25

Syntax: 25}

Parameter Name	Data Type	Description
-	-	-

Receive from Controller - Command ID 25

Syntax: 25|OnTime}

Parameter Name	Data Type	Description
OnTime	uint32	The amount of time at least one LDD has been enabled since the first valid configuration. Each count represents 15 minutes of on time.

Example:

Send Command	Receive Command	Explanation
25}	25 345}	The returned value shows the system has been on for $(345 * 15 / 60) = 86.25$ hours.

AddSystemOnTime

Description

Adds hours to the system on time count. This command exists only to bring older controllers up-to-date.

Send from Computer - Command ID 30

Syntax: 30|Hours}

Parameter Name	Data Type	Description
Hours	uint32	The number of hours to add to the on time of this laser controller.

Receive from Controller - Command ID 4

Syntax: 4|LaserError}

Parameter Name	Data Type	Description
LaserError	uint8	The error (if any) which occurred during command execution. Return value is 0 for successful execution. See definition of error codes for more details.

Example:

Send Command	Receive Command	Explanation
30 10}	4 0}	Attempts to add 10 hours to on time. Response indicates OK status.

A.2 Binary Commands

For faster performance, it may be useful to request state information from the laser controller in binary format. The State commands presented in the ASCII section have corresponding binary versions. These binary commands are sent using the following format:

Byte Index	Value
0	Command ID
1 to 2	Number of bytes of data (N)
3 to N+2	Data

There is no termination character for binary commands. The data sent with each binary command response will be a struct of the parameters presented in its ASCII counterpart.

As an example, to request the global state parameters (command ID 131) you would send three binary bytes: [131][0][0]. You would then receive 16 bytes in response: [131][0][13][13 data bytes].

The following C# code can be used to extract arguments from the byte array read from the laser controller:

```
public static T GetFromBytes<T>(byte[] inVal, int startIdx) where T :
new()
{
    T RetVal = new T();
    int SizeOfT = Marshal.SizeOf(RetVal);
    if (SizeOf > inVal.length - startIdx)
        throw new IndexOutOfRangeException("Insufficient binary data to
execute ReadArg<" + RetVal.GetType().Name + ">()");

    IntPtr Ptr = Marshal.AllocHGlobal(SizeOfT);
    Marshal.Copy(inVal, startIdx, Ptr, SizeOfT);
    RetVal = (T)Marshal.PtrToStructure(Ptr, typeof(T));
    Marshal.FreeHGlobal(Ptr);
    return RetVal;
}
```



The easiest way to work with the binary commands is to use the above function to read all the bytes into a single struct:

```
CommandDataStruct data = GetFromBytes(DataBytes, 0);
```

The definition of `CommandDataStruct` is present with each binary command which follows.



GetGlobalStateBinary (ID 131)

This command has the same parameters as GetGlobalState (ID 14)

The following C# struct definition can be used to read the binary data:

```
[StructLayout(LayoutKind.Explicit, Pack = 1, Size = 14)]
private struct GStateBin
{
    [FieldOffset(0)]
    public byte Err;
    [FieldOffset(1)]
    public byte CLevel;
    [FieldOffset(2)]
    public byte Idx;
    [FieldOffset(3)]
    public byte Interlock;
    [FieldOffset(4)]
    public byte IsLaserOn;
    [FieldOffset(5)]
    public byte IsPilotOn;
    [FieldOffset(6)]
    public byte ExtCtrlMode;
    [FieldOffset(7)]
    public byte IsAPCon;
    [FieldOffset(8)]
    public byte StageCnt;
    [FieldOffset(9)]
    public byte SensorCnt;
    [FieldOffset(10)]
    public byte OutputPower;
};
```



GetGlobalStateBinary (ID 132)

This command has the same parameters as GetLDDState (ID 15)

The following C# struct definition can be used to read the binary data:

```
[StructLayout(LayoutKind.Explicit, Pack = 1, Size = 7)]
private struct LDD_StateBin
{
    [FieldOffset(0)]
    public byte Error;
    [FieldOffset(1)]
    public byte IsEnabled;
    [FieldOffset(2)]
    public float AmpsVal;
    [FieldOffset(6)]
    public byte Stage;
};
```



GetSensorStateBinary (ID 133)

This command has the same parameters as GetSensorState (ID 16)

The following C# struct definition can be used to read the binary data:

```
[StructLayout(LayoutKind.Explicit, Pack = 1, Size = 5)]
private struct Sensor_StateBin
{
    [FieldOffset(0)]
    public byte Error;
    [FieldOffset(1)]
    public float Val;
};
```



GetStageStateBinary (ID 135)

This command has the same parameters as GetSensorState (ID 16)

The following C# struct definition can be used to read the binary data:

```
[StructLayout(LayoutKind.Explicit, Pack = 1, Size = 8)]
private struct Stage_StateBin
{
    [FieldOffset(0)]
    public byte Error;
    [FieldOffset(1)]
    public byte LDDCount;
    [FieldOffset(2)]
    public byte LDDEnabledCount;
    [FieldOffset(3)]
    public byte IsHwEnabled;
    [FieldOffset(4)]
    public uint16 AmpsPercent;
    [FieldOffset(6)]
    public uint16 PowerPercent;
};
```

Appendix B - Error Codes

Code ID	Name	Description
0	OK	No error.
1	Interlock	Interlock circuit is open, or soft interlock is active.
2	NoComm	Communications timeout. On most systems, it is necessary to send a command (such as a GetState) at least every 5 seconds. Otherwise, the unit will assume communications have been interrupted and shut down the laser for safety purposes.
3	NoReverseHwEnable	Reverse power protection circuit has been activated and disabled the stage.
4	AuxOverTemp	Sensor temperature limit has been exceeded.
5	InputSignal	Input signal to the stage is too low.
6	BadDACOutput	The DAC is malfunctioning (electronics failure).
7	OverTemp	Diode temperature limit has been exceeded.
8	NoHwEnable	Input power protection circuit has been activated has disabled the stage.
9	-	Unused
10	NeedInit	Loading configuration data from the EEPROM was unsuccessful.
11	BadArg	An incoming command was sent with an invalid value for one of the parameters.
12	Other	Returned when no other error code applies.
13	PreviousStageOff	The laser diode cannot be enabled because a previous stage is currently off.
14	BadLaserEnabled	The hardware SUM_ENABLE signal is inconsistent with the current laser status (electronics failure).
15	LaterStageOn	The stage cannot be disabled because a later stage is currently active.

16	BadCmdExtCtrl	A called command is not allowed in External Control Mode.
17	StageOnOffDelay	The previous stage was turned on too recently to activate the current stage, or the follow stage was turned off too recently.
18	SensorGenThresh	The sensor has exceeded its threshold.
19	SensorDeriv	The sensor has detected an unexpected or unacceptable rate of change.
20	MainPowerDeriv	An unexpected drop in output power has been detected, indicating a potentially serious problem.
21	AmpsLocked	The attempt to adjust the set point on a locked laser diode was rejected.
22	NotAvail	Command is not supported on this system.